





200/500 Series Telephones



200/500 Series Telephones

- 500 video features 3.5" LCD colour screen
- Electronic ringer with adjustable volume
- Plug-in handset
- Mute switch
- Dual camera mode
- Door status monitoring

The Entryphone® 200 (audio) and 500 (video and audio) series telephones feature similar styling but differ slightly depending whether audio or video is required. Model variants allow features in addition to door release such as dual camera control, door monitoring, ring mute, porter call and other ancillary switching requirements.

- Lock release switch and door open indicator 
- Ring mute switch and indicator 
- Auxiliary switch (eg porter, second lock etc.) 
- Dual camera switch 
- On switch 

*Symbols shown for 530 type phones, symbols vary for other models

Desk-Mounted Options

The 530 series telephones are designed for wall fixing but most models can be adapted for desk mounting with an appropriate desk plate and conversion kit.

Dimensions (mm)

Height	Width	Depth
195	90	60

Video on 5 Wires

Upgrade existing audio systems to video without re-wiring with Entryphone® 500 series.

Audio

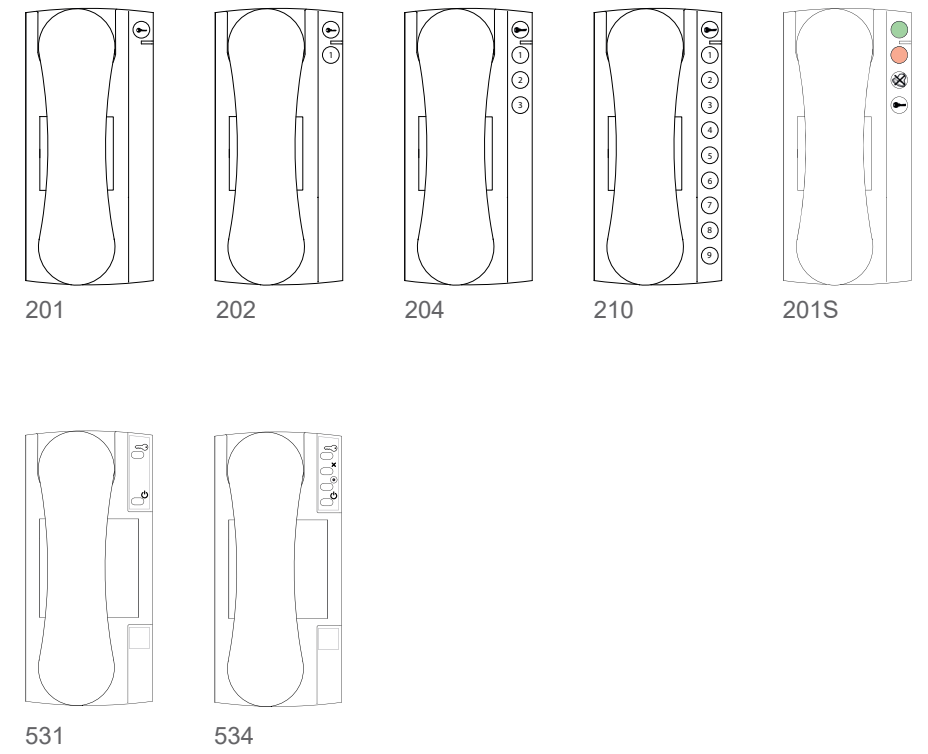

Video

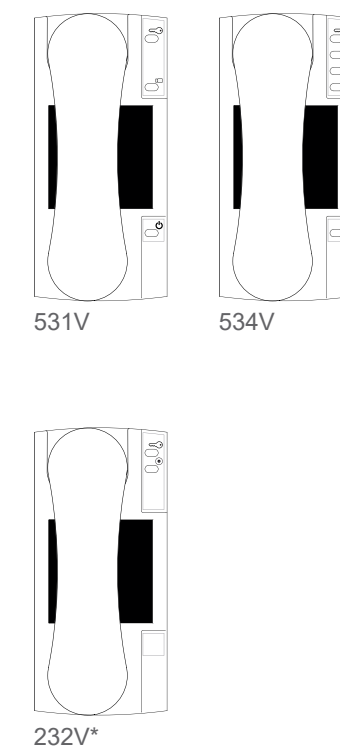

Desk kit for 200/500 series

* Note: 232V model is a compatible replacement video telephone for 900 and 200 series systems only. For new video installations use 500 series.

PTS Series Telephones







530PTS

- High definition 3.5" colour LCD screen
- Electronic ringer
- Semi-flush fitting option
- Portrait or Landscape versions
- No Handset

The Entryphone® 530PTS is a wall mounted loudspeaking colour video telephone. The PTS has no handset but instead has a large paddle push button to operate the speech. The 3.5" LCD screen gives a clear picture and there is no handset or cord to get in the way.

The PTS stands out from a wall by only 38mm but with its rebated design it can be fitted semi-flush reducing the apparent depth to less than 20mm. Available in landscape or portrait versions the PTS fits almost anywhere.

The PTS series telephones are available in various configurations to facilitate release, door monitoring and mute functions as may be required.

- Lock release switch and door open indicator 
- Ring mute switch and indicator 
- Auxiliary switch (eg porter, second lock etc.) 
- Dual camera switch 
- On switch 

An angled desk conversion kit is available so the unit can be fitted freestanding.

Dual Camera
Entryphone® 500 series has two camera inputs with auto-switching giving two views of a caller.



Dimensions (mm)

Height	Width	Depth
90	195	40

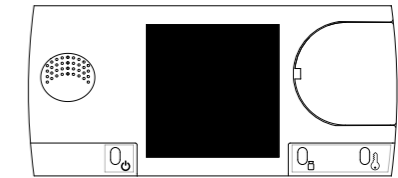

531PTS

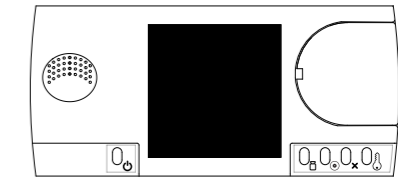

534PTS

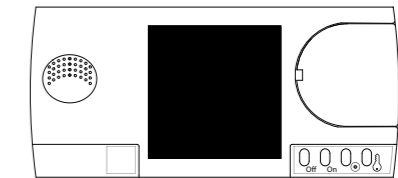

234PTS*



Dimensions (mm)

Height	Width	Depth
195	90	40

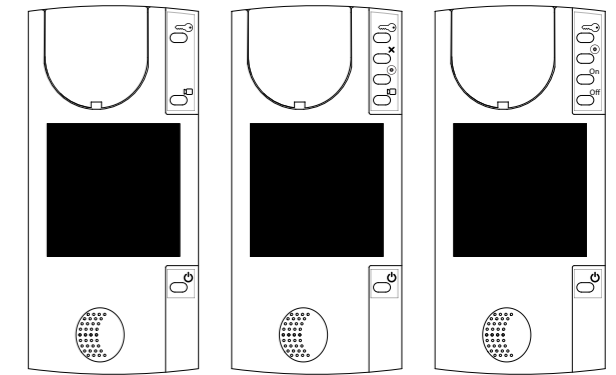

531PTSP

534PTSP

234PTSP*

* Note: 234 models are compatible replacement video telephones for 900 and 200 series systems only. For new video installations use 500 series.

FPV Series Telephones



530FPV

- 3.5" colour LCD screen
- Mirror or brushed stainless steel
- Electronic ringer
- No handset
- Hidden magnetic fixings

The Entryphone® 530FPV is the stainless steel plate version of the PTS colour video telephone.

This unit is intended for new-build or refurbishments where the back box is flushed into the wall during building work.

The 530FPV telephones is available in either brushed or mirror polish stainless in two models to facilitate release, second camera switching, door monitoring, mute functions and porter call as may be required.

Lock release switch and door open indicator



Ring mute switch and indicator



Auxiliary switch (e.g. porter, second lock etc.)



Dual camera switch



On switch



Mirror polish stainless steel

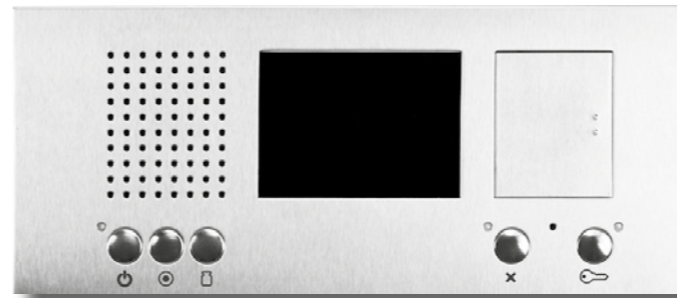

Brushed stainless steel

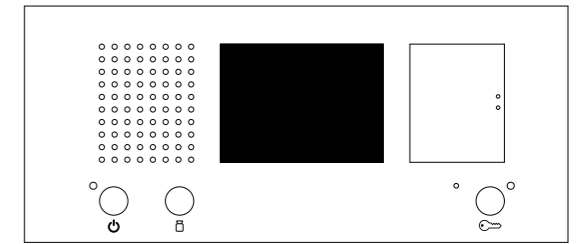

531FPV

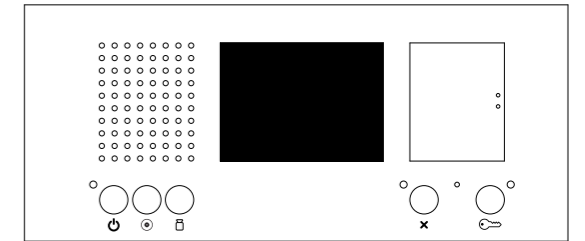

534FPV

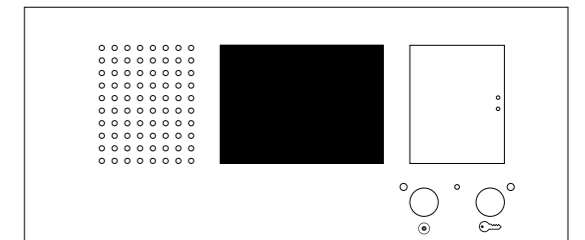

232FPV

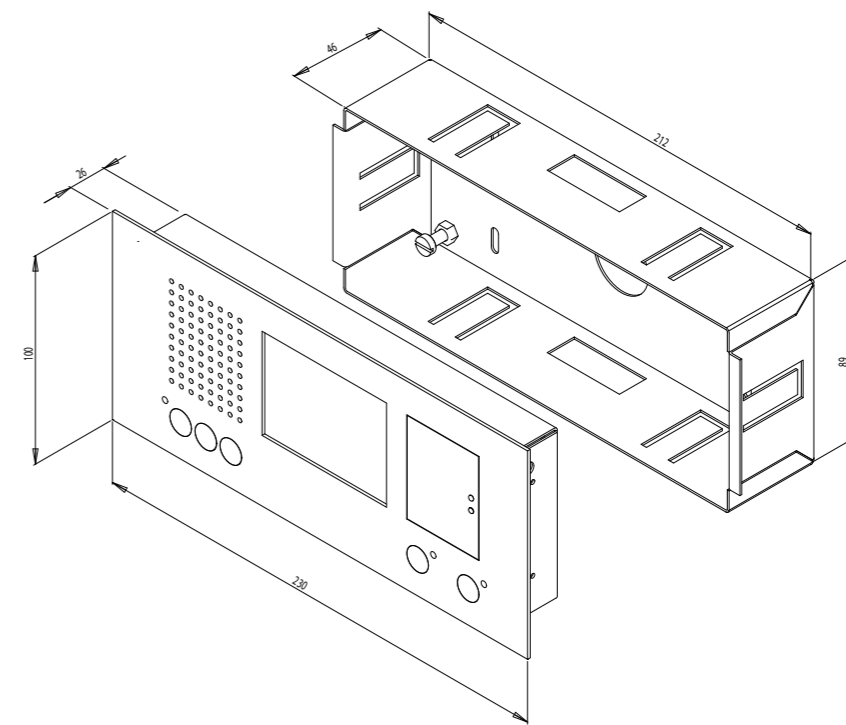

* Note: 232FPV model is a compatible replacement video telephone for 900 and 200 series systems only. For new video installations use 500 series.

9200/1 Entrance Units



Single Button Units 9200/1

- Video compatible
- Flush metal capped button
- Choice of finishes
- Tamper resistant fixings
- 5900 range compatible

The Entryphone® 9200/1 single button panel presents a very compact unit for where only a single ringing line is needed; available in brushed stainless steel, mirror polish stainless steel and polished brass (unlacquered). All units contain a weather-resistant speech module, a flush metal button and tamper-resistant hex-key fixings.

Units can be ordered either as audio or video versions.

These units are supplied either with a surface frame (standard) or with a back box for flush fitting. For the stainless steel finish, the surface frames are made in the same material as the panel but for polished brass units the frames are made in solid oak.

200/500 Series Compatible

All entrance panels can be supplied with either 200 or 500 series telephone speech components.

Plates



Brushed 316 Stainless Steel



Polished 316 Stainless Steel



Polished CZ108 Brass

Dimensions (mm)

216 (H) 89 (W) (1.5mm gauge)

Surface Frames and Back Boxes



Dimensions (mm)

Back Box				Metal Surface Frame			Oak Surface Frame				
	H	W	D		H	W	D		H	W	D
Audio	203	76	34	Audio	216	89	40	Audio	216	89	30
Video	203	76	46	Video	216	89	52	Video	216	89	42

9200 Series Entrance Units



9200 Multi-button

- Video compatible
- Flush metal capped button
- Tamper resistant fixings
- Available in brushed stainless, mirror, polished stainless and polished brass

The Entryphone® 9200 multi-button entrance panels are available, from stock, in sizes from a two button up to a thirty button unit and in larger sizes to special order. All units incorporate weather-resistant speech components, flush metal buttons, rear-illuminated name inserts and tamper-resistant hex-key fixings. Available as standard in brushed stainless steel and mirror polish stainless steel or, to special order, in un-lacquered polished brass.

CCD Video

All 9200 panels may be ordered fitted with colour CCD video camera. The camera module, incorporating miniature high resolution solid state CCD camera, is designed to be fitted behind the speech module and the logo insert is changed to a lens.

Surface or Flush

All multi-button panels are supplied complete with 22swg galvanised steel back box for flush fitting. These allow the plate to overlap by 19mm all round to cover inaccuracies when cutting into the wall. Where it is impractical to flush in a door panel, surface frames are available. There are two types, either stainless steel hood-style frames or solid oak frames.



A type

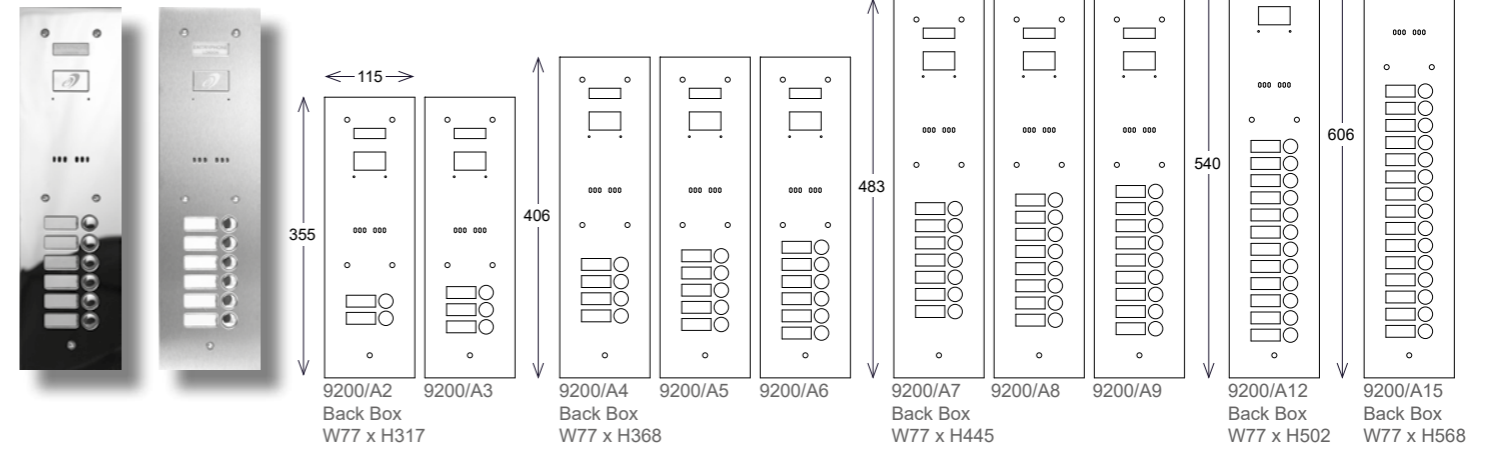

B type

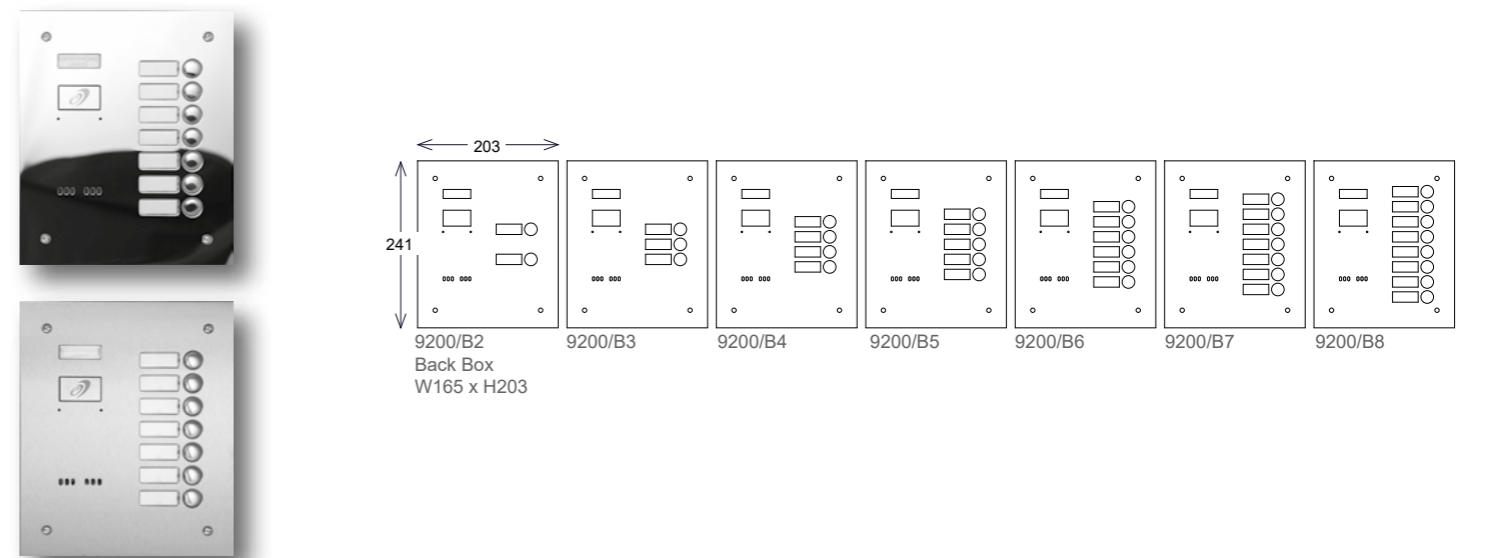

C type

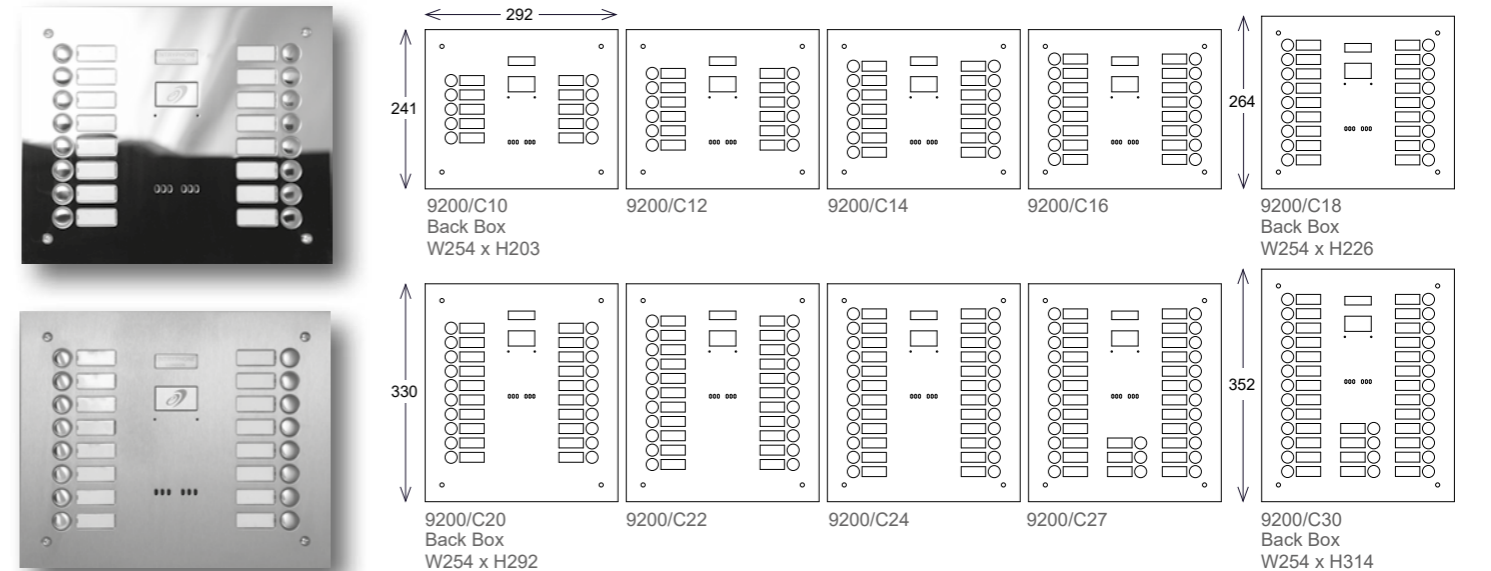

VR Series Entrance Units



VR Range

- Video compatible
- Low profile stainless buttons
- Laser engraved lettering
- Tamper resistant fixings
- Available in brushed or mirror polish stainless steel

The Entryphone® VR panels are made to order for when it is considered that the units are particularly prone to undesirable attention. Although similar in shape to the standard panels, instead of interchangeable name inserts, numerals are laser engraved into the panel alongside each button. The buttons themselves are shrouded and extremely robust. All units are supplied with weather-resistant speech module, and tamper-resistant hex-key fixings.

Units can be ordered either as audio or video versions or if required be updated to video at a later date.

Made to order

As well as our standard sizes, special 9200 and VR panels are available made to order. Occasionally circumstances dictate that a standard shape panel will not fit in the space available or additional items are required, such as a proximity reader, coded access or special engraving. Let us know your requirements and we will prepare a drawing for your approval.

VR/A

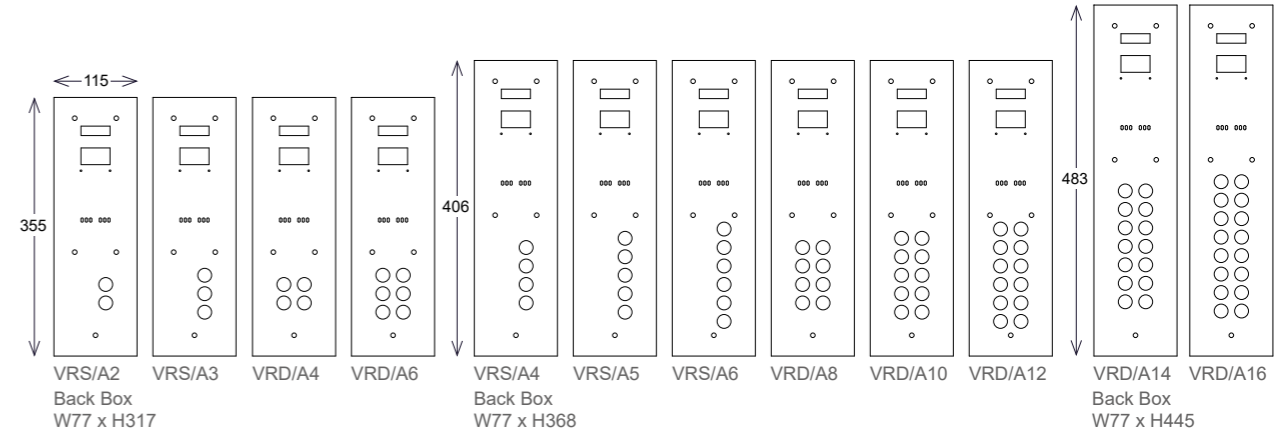

VR/B

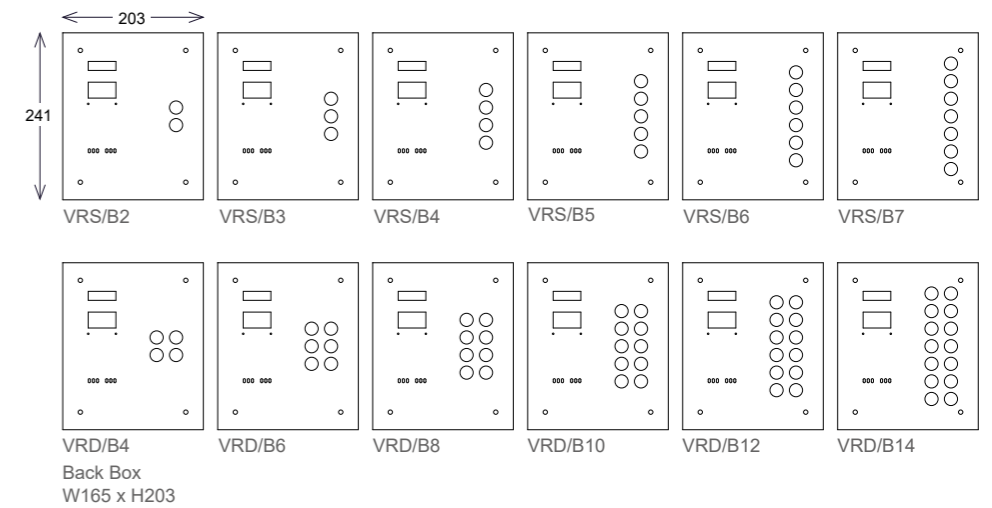

VR/C

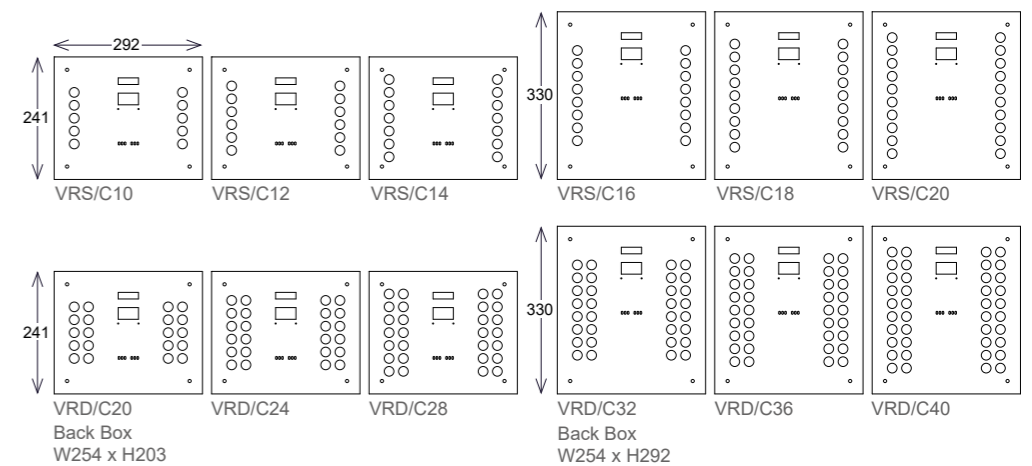
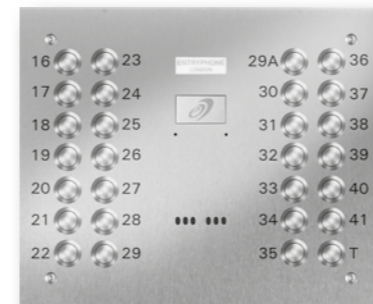

5DDP Series Digital Entrance Units

- Dual camera option

- 5-Wire Video compatible

- Etched, back-lit stainless steel keypad

- Integrated Coded Access

- Integrated PinNet proximity reader

- Available in brushed or mirror polished stainless steel

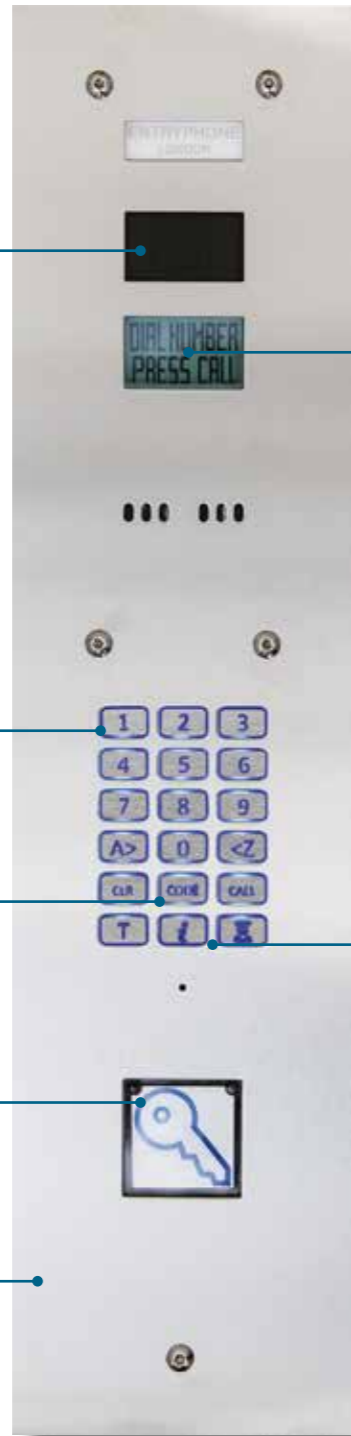

- Sunlight readable LCD display

- Visual and Audio feedback for DDA Compliance

- Key-pad or USB memory set-up

- Two direct call buttons



Part No.	Description
5DDP-S	500 Series Digital Dial Panel <i>Finish: Brushed Stainless Steel</i>
5DDP-M (illustrated)	500 Series Digital Dial Panel <i>Finish: Mirror Polished Stainless Steel</i>

Dimensions (mm)

	Height	Width	Depth
Plate	406	115	-
Back Box	368	77	38

500 Series Digital Dial Panel

The Entryphone 5DDP series Digital Dial Entrance Panels provide calling for up to 240 telephones. It offers a compact alternative to the conventional individual call button type panels especially for larger blocks of flats or offices. It is also ideally suited for situations where expansion of a system is likely.

The DDP has a default set-up that will suit the majority of installations and generally little or no programming is required and the unit will work straight out of the box. However, the DDP can be programmed either via its own keypad or using a USB memory stick giving options for alpha numeric numbers, individual name display, audible feedback and ring and release times.

Coded access is built in as well as dedicated buttons for a trade's time-switch and two direct call buttons for where there is porter or office presence.

Available with or without a PinNet proximity reader and in two standard finishes, either brushed or mirror polish 316 stainless steel. The 5DDP can also be made to special order to custom dimensions.



Part No.	Description
5DDPPN-S (illustrated)	500 Series Digital Dial Panel with integrated PinNet Reader <i>Finish: Brushed Stainless Steel</i>
5DDPPN-M	500 Series Digital Dial Panel with integrated PinNet Reader <i>Finish: Mirror Polished Stainless Steel</i>

Dimensions (mm)

	Height	Width	Depth
Plate	483	115	-
Back Box	445	77	38

TeleDial GSM Digital Entrance Unit



- Takes a standard micro SIM from any of the mobile networks

- Optional Address Line

- Visual and Audio feedback for DDA Compliance

- Text-based or web-portal programming

- Integrated time profile coded Access

- Two direct call buttons

- 3.5" LCD Display for clear context sensitive visual feedback

- Caller ID dial-in door release

- Etched, back-lit stainless steel keypad

- Alpha key entry

- Trades facility with weekly time profile

- Available in brushed or mirror polished stainless steel



Part No.	Description
TDD-S	TeleDial GSM Digital Dial Panel <i>Finish: Brushed Stainless Steel</i>
TDD-M	TeleDial GSM Digital Dial Panel (illustrated) <i>Finish: Mirror Polished Stainless Steel</i>

Dimensions (mm)

	Height	Width	Depth
Plate	406	115	-
Back Box	368	77	38

Part No.	Description
TDDPN-S	TeleDial GSM Digital Dial Panel with integrated PinNet Reader <i>Finish: Brushed Stainless Steel</i>
TDDPN-M	500 Series Digital Dial Panel with integrated PinNet Reader <i>Finish: Mirror Polished Stainless Steel</i>

Dimensions (mm)

	Height	Width	Depth
Plate	483	115	-
Back Box	445	77	38

TeleDial GSM Digital Dial Panel

The TeleDial GSM Door Intercom offers a wireless door entry solution using mobile phone technology. The unit translates a dialled flat or office number and makes a call to any mobile or land line, allowing a conversation to take place and the door or gate to be released. The unit is programmable for up to 250 users with either one or two numbers per user.

The TeleDial GSM offers an economical solution for door entry particularly where wiring is difficult or undesirable and the compact back-lit key-pad offers an excellent alternative to the conventional individual call button type panels, especially for larger blocks of flats or offices. It is also ideally suited for where off-site communication is required or, situations where expansion of a system is likely.

Coded access and Caller ID Access is built-in and the unit also features dedicated buttons for trade's time-switch or for calling direct to a porter or an office. Settings and user numbers are easily changed using our SMS messages or our web-based portal.

5,5 to release the door.

When a call is received, using the standard telephone key-pad on their telephone the resident simply dials 5,5 to admit visitors (or 6,6 for a second door or vehicle gate).

Answering machine or voice-mail response can be avoided by adding a tone to the beginning of the receiver's voice-mail greeting.

The TeleDial GSM is available with or without a PinNet proximity reader and in two standard finishes, either brushed or mirror polish 316 stainless steel. It can also be made, on special order, to custom dimensions.

DL Series Door Releases



DL141

Entryphone® releases have the same basic form of operation but vary in their physical dimensions, method of fixing and finish.

A swivel plate replaces the keep or staple of a standard night latch (Yale, Union etc.) and in its static condition acts as a normal keep. When voltage is applied a link removes a stay pin from this swivel plate and this allows the door to be pushed open as the tongue of the latch lock can pass the swivel plate. As soon as the lock has passed the swivel plate a spring resets it to its locked position. While the current is applied to the solenoid, the linkage provides a small amount of buzzing and this gives an indication to the visitor that the door is ready to be opened.

An electric release does not interfere with the normal operation of a mechanical lock, thus the door can be opened by the lever or knob on the inside and by usual key on the outside.

Security and Electric Releases

The addition of an electric door opener to a conventional night latch may reduce the strength of the door or negate some security features of the lock. It is important that these security issues are understood and that the most suitable device is chosen for the circumstances and the level of security required.

Rim



DL141/R
Standard Grey

Rim versions

- DL141/R **standard device**
- DL141/R-C **chrome finish**
- DL141/R-P **polished brass finish**
- DL141/R-CH with door open switch
- DL141/R-MA momentary action
- DL141/RO for outward opening double doors
- DL141/FF-C face fixing - chrome
- DL141/FF-P face fixing - polished brass
- DLING-C for Ingersoll - chrome
- DLING-P for Ingersoll - polished brass
- DL141/BANG for Banham latch - gold paint finish
- DL141/BANS for Banham latch - silver paint finish
- DL141/R-DJ deep jaw
- DL141/R-FO fail open

Mortise



DL141/M
Standard Grey

Mortise versions

- DL141/M **standard device**
- DL141/M-C **chrome finish**
- DL141/M-P **polished brass finish**
- DL141/M-AJ with adjustable jaw
- DL141/M-CH with door open switch
- DL141/M-DC for DC operation (100%)
- DL141/M-DJ with deep jaw
- DL141/M-FO power fail-open (100%)
- DL141/M-MA momentary action
- DL31L short body - for uPVC doors
- DL1703 for aluminium doors (ANSI standard cut-out)

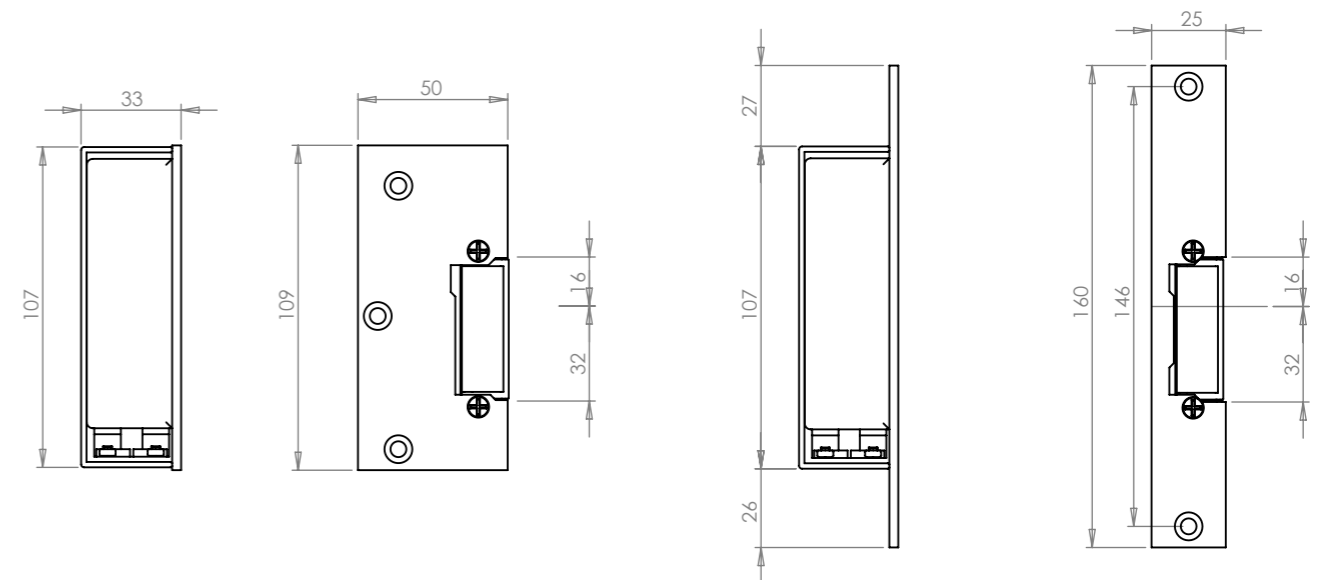

CISA® Electric Lock



CISA® Lock

The CISA lock differs from the latch/release arrangement in that the moving parts of the releasing mechanism are in the lock itself and not in the keep, which is fixed in the same way as a conventional lock keep.

The CISA lock gives two particular advantages over a standard release: It is stronger than a conventional release and is not prone to being slipped (i.e. using a piece of plastic to force back the tongue of the lock).

However, the following should be considered:

Noise. The CISA lock requires more current to operate it than a standard release as its solenoid needs more power to release its mechanism. Therefore when it is operated the solenoid is relatively noisy and the "clack" of the lock withdrawing is also comparatively loud.

Momentary action. Once the CISA lock has been operated, either electrically or locally (using the button on the casing), the lock will remain unlocked until the door has been opened and re-closed; it is the action of the door being closed that sets the device. If the device is operated accidentally this will mean the lock will remain open until the next time the door is opened and re-closed.



Part No.	Description
CISA-LH	Left handed electric lock - standard device for inward opening wooden doors (illustrated).
CISA-RH	Right handed electric lock - standard device for inward opening wooden doors.



Part No.	Description
CISA-G-LH	Left handed electric lock with galvanised case suitable for external use on inward opening doors or gates.
CISA-G-RH	Right handed electric lock with galvanised case suitable for external use on inward opening doors or gates (illustrated).

Wiring

As the electrical components are in the lock itself the wiring for the CISA has to be run across the hinge of the door (using a door loop) and then across the door itself. Wiring to the lock can be rather obtrusive. It is possible, however, to conceal the wiring but this may involve removing architraves and routing the edge of the door.

Drawing shows right handed CISA lock fitted to a single wooden door with door loop and typical wiring route.

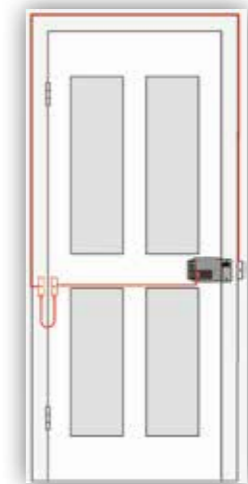

Handing

The CISA lock differs depending on which side of a door it is to be fitted. It is important to specify whether a left or right handed lock is required.

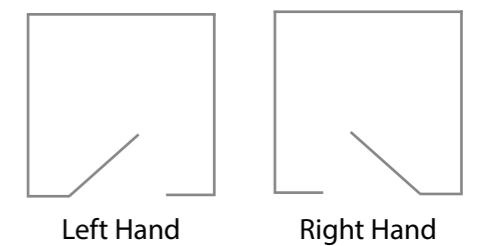

M Series Magnetic Locks

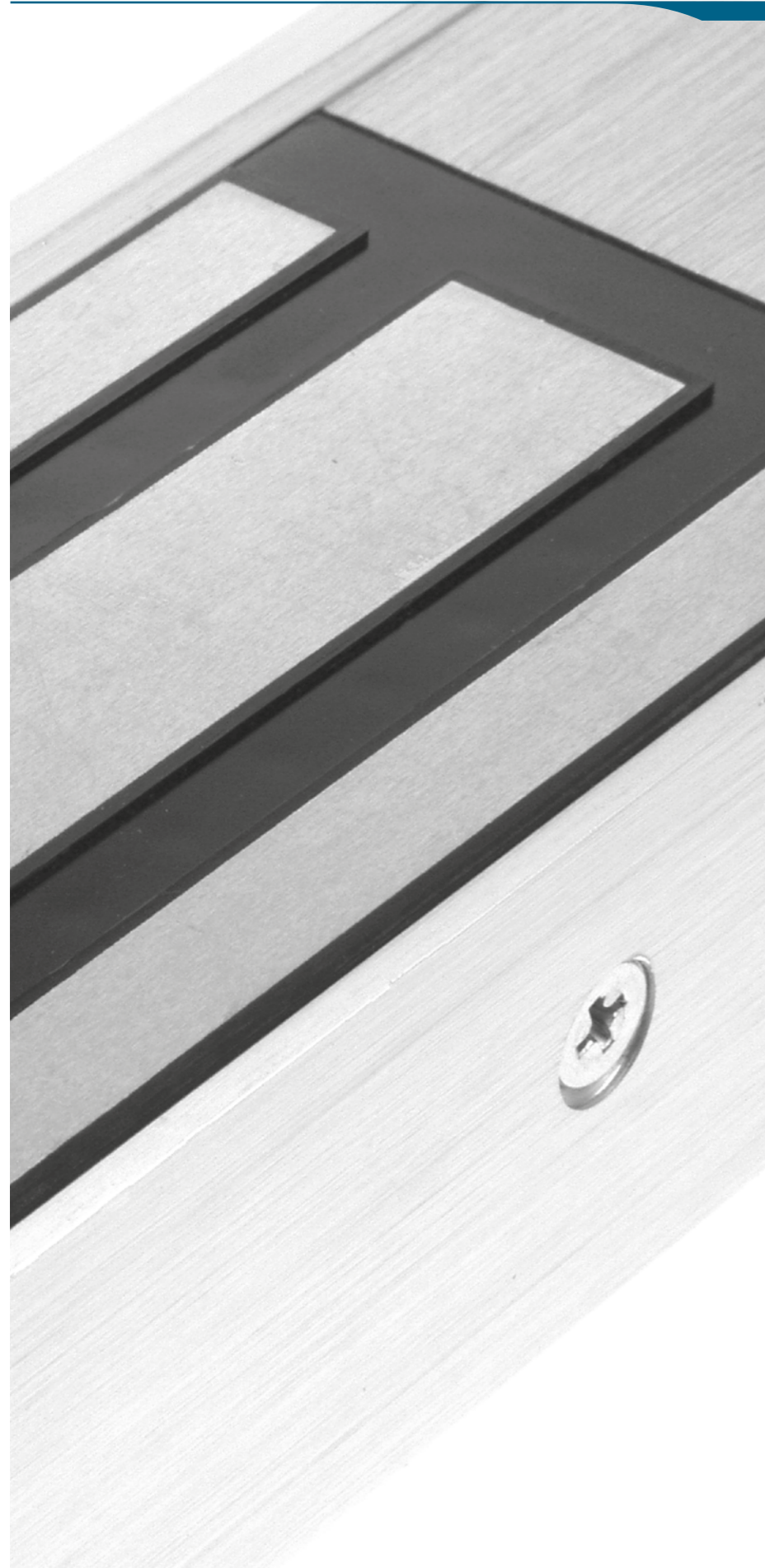

Magnetic Lock

The magnetic lock or maglock is an electric locking device that consists of an electromagnet and an armature plate. By attaching the electromagnet to the door frame and the armature plate to the door, voltage passing through the electromagnet attracts the armature plate holding the door shut.

Entryphone® stocks two sizes of maglocks, the standard unit which has a holding strength of 1200lbs and a mini version with a holding strength of 600lbs.

Unlike an electric release a magnetic lock has no mechanical interconnecting parts and is therefore very durable which makes it valuable in a high-traffic environment. However, because the maglock has no means of being operated mechanically, electronic authentication is necessary (eg coded access, proximity access control, press to exit switch etc).

A maglock is a fail-open device (i.e. it needs power to remain locked) which, for fire safety is an important feature. If a maglock is fitted on an escape or fire route a "break-glass" unit should be fitted in addition to any egress button.



Part No.	Description
ML1200	Standard Magnet 1200lbs H74mm W265mm D40mm
MML600	Mini Magnet 600lbs H47mm W256mm D26mm

Fitting
A maglock is usually fitted at the top of a door with the magnet fixed to the frame and the armature fitted to the door. Different fixing plates are required depending on which way the door opens and the thickness of the door frame.



MLAH	Magnetic lock armature housing
MMLAH	Mini-Magnetic lock armature housing
	recommended for an outward opening door

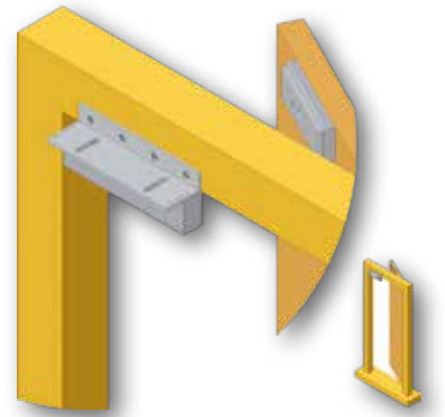

MLLP	Magnetic lock L Plate
MMLLP	Mini-Magnetic lock L Plate
	required for an outward opening door with a narrow door fame

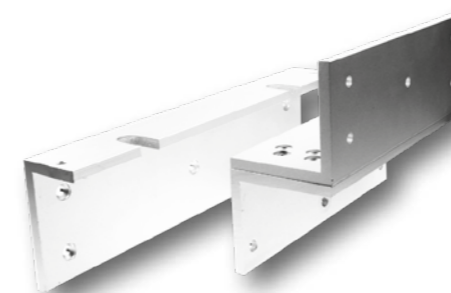
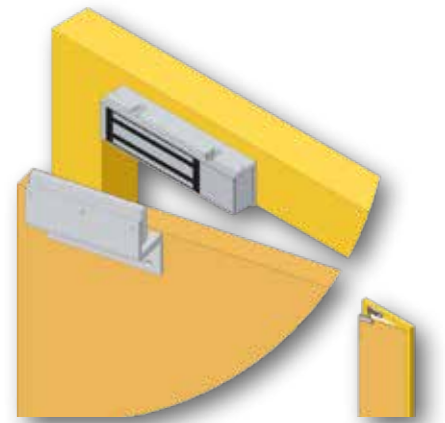

MLLZP	Magnetic lock LZ plates
MMLLZP	Mini-Magnetic lock LZ plates
	required for an inward opening door

CA8 Coded Access



CA8 - Coded Access

- Back lit metal keypad
- 32 Codes
- Two 6 AMP output relays
- 1-8 digit codes
- Master code secure programming
- Stand alone or integrated

The CA8 coded access system gives an extra dimension to an Entryphone® system providing additional features that enhance convenience and security.

While visitors can be admitted in the usual way using the Entryphone® system, a problem arises when authorised personnel need to gain access. The usual method to allow entry for an authorised person is to issue them with a key; however, this can cause problems if a key is lost or stolen or the individual is no longer authorised. Changing the lock and re-issuing keys can be expensive and inconvenient.

The coded access system solves these problems. By entering the correct 1-8 digit code, authorised personnel can gain access. No keys are necessary and the code numbers and the release time can be changed quickly and easily by the use of the master code.

Available in brushed or mirror polished stainless steel.



- CA8/S-M Mirror stainless surface mounted
- CA8/F-M Mirror stainless flush mounted
- CA8/S-S Brushed stainless surface mounted
- CA8/F-S Brushed stainless flush mounted

Dimensions (mm)
Height Width Depth

surface frame			
216	89	38	
back box			
203	76	38	

Integrated unit

As well as our standard coded access units all our entrance panels can be ordered with our coded access module fitted as an integrated unit. We will submit a drawing detailing the layout for approval before manufacturing the panel.

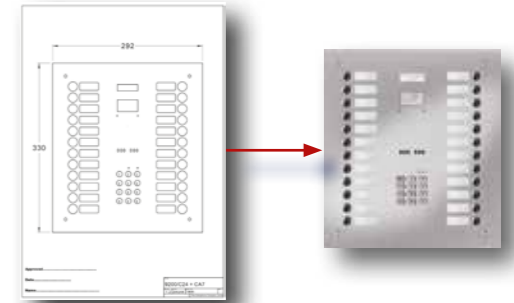

- 92CA8-M Mirror stainless single button entrance panel and coded access
- 92CA8-S Stainless stainless single button entrance panel and coded access

Dimensions (mm) Height Width Depth

plate	355	115	
back box	317	77	38

supplied with back box for flush fitting order
separate surface frame MF/A3 if required.

PinNet Access Control



PinNet4

- Off-line or on-line administration
- Password protected
- Keys added or deleted using secure GSM activation codes
- Key only, key and PIN or PIN only options
- No software required - web browser programming
- 1000 record log
- 1000 key capacity
- 4 door capacity
- 8 time profiles
- Optional key expiry or start date
- Secure one-day password
- No master keys

The PinNet4 is an access control system for apartment blocks or office buildings. Where there is no on-site administrator, Entryphone® offers off-line or on-line administration services. Keys can be added or deleted using a unique encrypted activation code or via the PinNet4's built in web-server or the unit's GSM modem.



Part No. Description

PN4CU PinNet Control Unit

Dimensions (mm)

Height	Width	Depth
350	205	65



Part No. Description

PN4RF PinNet Reader - flush
 PN4RS PinNet Reader - surface

Dimensions (mm)

Height	Width	Depth
85	85	38



Part No. Description

PN4RKF PinNet Reader & Keypad - flush
 PN4RKS PinNet Reader & Keypad - surface

Dimensions (mm)

Height	Width	Depth
216	89	38

Keys

The PinNet4 can be factory programmed by Entryphone® before it is supplied and the key and programme records are contained in the unit's memory. Every key has a unique serial number laser engraved onto it and we keep a secure record of every key we supply.



Built-in Web Server

With a built-in Web server, the PinNet4 can be connected directly to a PC or to an IP network and programmed using any web browser.

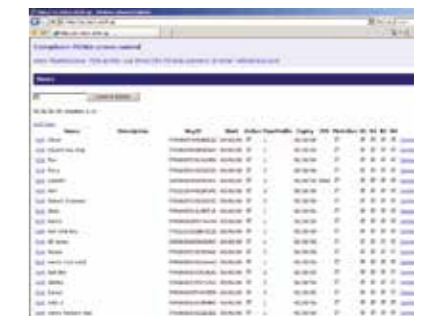

Power supplies, relays and switches

Power Supplies



Part No.	Description
DA97	Audio power supply.
DA97-R	As DA97 but with a relay for switching locks direct e.g. CISA.
DA12	12v D.C. 2amp power supply suitable for intermittent use.
DA20-R	Video booster power supply for larger video systems.
DA500	500 series video power supply (for up to 5 phones).

Dimensions (mm)	Height	Width	Depth
	150	127	100



Part No.	Description
900C-PSU	200 series video systems power supply.
500-PSU	500 series video systems power supply (for systems from 5 to 25 phones).

Dimensions (mm)	Height	Width	Depth
	305	235	100

500-AUX	500 series video systems auxillary power supply.
---------	--

Dimensions (mm)	Height	Width	Depth
	210	155	52



Part No.	Description
PSU-12V2A	2 amp power supply suitable for Maglocks. Includes a trickle charging circuit for a rechargeable battery (not included).

Dimensions (mm)	Height	Width	Depth
	200	230	80

Part No.	Description
PSU-12V3A	3 amp power supply suitable for Maglocks. Includes a trickle charging circuit for two rechargeable batteries (not included).

Dimensions (mm)	Height	Width	Depth
	330	360	85

System Relays



Part No.	Description
IC7RU	Intercom relay.
99RU	Audio 2 door auto relay.
99VRU	Video 2 door auto relay.
900-VS4	75 ohm coaxial four-way video splitter.
500-DCU	500 series door capture relay.
500-VS4	500 series four way video splitter.

Dimensions (mm)	Height	Width	Depth
	150	127	50

Switch Relays



Switch relays suitable for local lock switching (eg Cisa lock), to interface with third party devices and timing functions.

GPRU	General purpose relay.
GPRU-BX	Boxed general purpose relay.
GPRU-DP	General purpose relay - double pole - PCB only.
GPRU-DP-BX	General purpose relay - double pole - boxed.
TMR11	Multi-function timer.

Switches

Digital time switch



12 volt digital seven-day time switch for provision of a trades facility. Eight daily time intervals, battery reserve and automatic GMT/BST adjustment.

TS2000-BST

Press-to-exit switches



Press-to-exit switches for use with maglocks or other access control devices.

PB-P/EXT/S	Stainless steel surface.
PB-P/EXT/F	Stainless steel flush.
PB-RTE-TMR	Exit timer.
PB-P/EXT/W	White (internal use).
PB-BRK-GLS	Break-glass emergency exit switch.